

Vide Panel



technical



Vide is a slimline panel system designed to provide workstation privacy while retaining a lightweight, elegant aesthetic. With a flexible range of heights and widths designed to suit many workstation lengths, Vide allows the user to personalise their work space.

Index

product overview **02**

side options | suspended panels **02**

bridged panels | accessories **03**

product specifications **04**



Vide Panel

product overview | side options | suspended panels

Vide panels are constructed with a 25 mm MDF core. Panels covered in fabric, MDF powder coat and laminate or timber veneers. Vide panels have not been designed to be freestanding, they are only available as desk suspended or bridge mounted. Panels with aluminium trims feature a 10.5 mm corner radius while rubber edged panels have a 50 mm corner radius. Edge finish options includes aluminium flat cover, transom rail and rubber extrusion.

SIDES OPTIONS

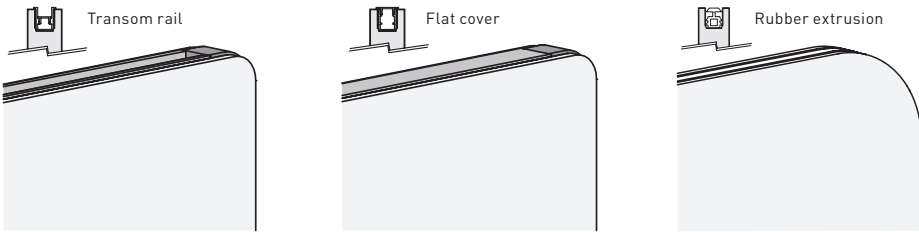

VIDE SUSPENDED PANELS

Vide suspended panels are available in a range of sizes and 4 options for edge trims. Panels mount to the back of the worksurface with a suspended panel bracket. Suspended panels are available for fixed worktop heights of 720mm with a maximum 900mm high Vide panel (300mm below desk/600mm above desk).

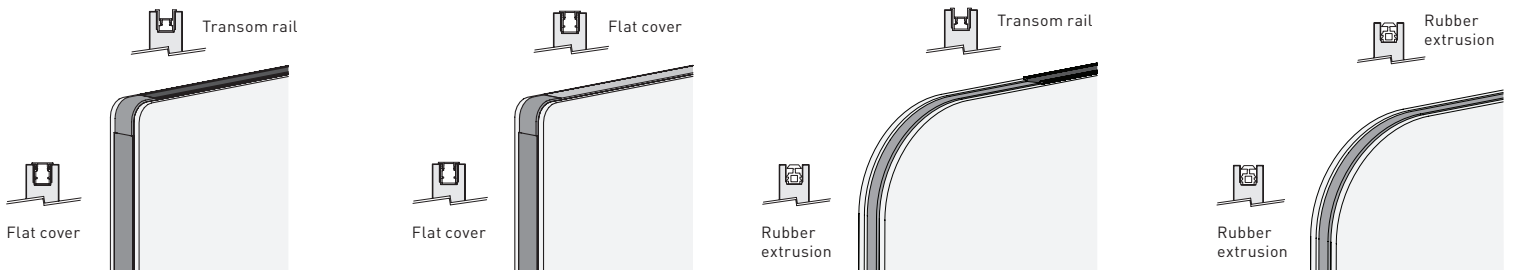
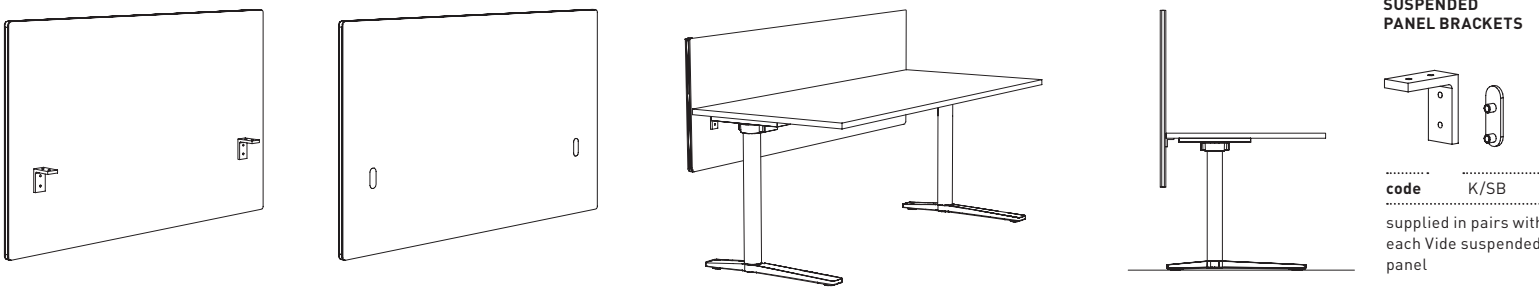

code	SVS-AT-0606	600 H x 600 W
	SVS-AT-0609	600 H x 900 W
	SVS-AT-0612	600 H x 1200 W
	SVS-AT-0615	600 H x 1500 W
	SVS-AT-0618	600 H x 1800 W
	SVS-AT-0906	900 H x 600 W
	SVS-AT-0909	900 H x 900 W
	SVS-AT-0912	900 H x 1200 W
	SVS-AT-0915	900 H x 1500 W
	SVS-AT-0918	900 H x 1800 W
	SVS-AT-1206	1200 H x 600 W
	SVS-AT-1209	1200 H x 900 W
	SVS-AT-1212	1200 H x 1200 W
	SVS-AT-1215	1200 H x 1500 W
	SVS-AT-1218	1200 H x 1800 W

Suspended panels with flat aluminium edges and aluminium transom top rail

code	SVS-AF-0606	600 H x 600 W
	SVS-AF-0609	600 H x 900 W
	SVS-AF-0612	600 H x 1200 W
	SVS-AF-0615	600 H x 1500 W
	SVS-AF-0618	600 H x 1800 W
	SVS-AF-0906	900 H x 600 W
	SVS-AF-0909	900 H x 900 W
	SVS-AF-0912	900 H x 1200 W
	SVS-AF-0915	900 H x 1500 W
	SVS-AF-0918	900 H x 1800 W
	SVS-AF-1206	1200 H x 600 W
	SVS-AF-1209	1200 H x 900 W
	SVS-AF-1212	1200 H x 1200 W
	SVS-AF-1215	1200 H x 1500 W
	SVS-AF-1218	1200 H x 1800 W

Suspended panels with flat aluminium edges all round

code	SVS-RT-0606	600 H x 600 W
	SVS-RT-0609	600 H x 900 W
	SVS-RT-0612	600 H x 1200 W
	SVS-RT-0615	600 H x 1500 W
	SVS-RT-0618	600 H x 1800 W
	SVS-RT-0906	900 H x 600 W
	SVS-RT-0909	900 H x 900 W
	SVS-RT-0912	900 H x 1200 W
	SVS-RT-0915	900 H x 1500 W
	SVS-RT-0918	900 H x 1800 W
	SVS-RT-1206	1200 H x 600 W
	SVS-RT-1209	1200 H x 900 W
	SVS-RT-1212	1200 H x 1200 W
	SVS-RT-1215	1200 H x 1500 W
	SVS-RT-1218	1200 H x 1800 W

Suspended panels with rubber edges and aluminium transom top rail

code	SVS-RF-0606	600 H x 600 W
	SVS-RF-0609	600 H x 900 W
	SVS-RF-0612	600 H x 1200 W
	SVS-RF-0615	600 H x 1500 W
	SVS-RF-0618	600 H x 1800 W
	SVS-RF-0906	900 H x 600 W
	SVS-RF-0909	900 H x 900 W
	SVS-RF-0912	900 H x 1200 W
	SVS-RF-0915	900 H x 1500 W
	SVS-RF-0918	900 H x 1800 W
	SVS-RF-1206	1200 H x 600 W
	SVS-RF-1209	1200 H x 900 W
	SVS-RF-1212	1200 H x 1200 W
	SVS-RF-1215	1200 H x 1500 W
	SVS-RF-1218	1200 H x 1800 W

Suspended panels with rubber edges all around

Vide Panel

bridged panels | accessories

VIDE BRIDGED PANELS

Vide bridged panels mount to the workstation bridges.
 Panels must stretch from bridge to bridge.
 Bridged panel brackets are supplied with all bridged panels.
 Bridged panels are fixed height, they will not move with the work surface.

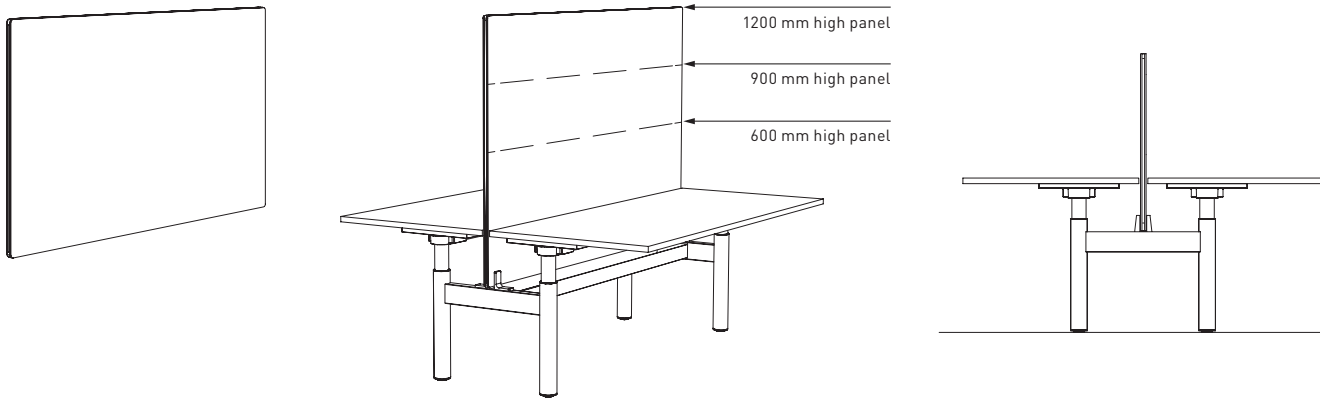

BRIDGE PANEL BRACKETS

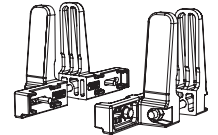

code K/BPB
 supplied in pairs with each Vide bridged panel

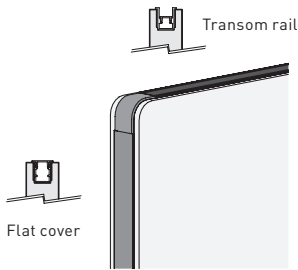

code	SVB-AT-0612	600 H x 1200 W
	SVB-AT-0615	600 H x 1500 W
	SVB-AT-0618	600 H x 1800 W
	SVB-AT-0912	900 H x 1200 W
	SVB-AT-0915	900 H x 1500 W
	SVB-AT-0918	900 H x 1800 W
	SVB-AT-1212	1200 H x 1200 W
	SVB-AT-1215	1200 H x 1500 W
	SVB-AT-1218	1200 H x 1800 W

Bridged panels with flat aluminium edges and aluminium transom top rail

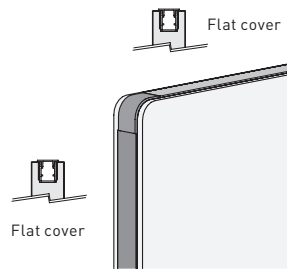

code	SVB-AF-0612	600 H x 1200 W
	SVB-AF-0615	600 H x 1500 W
	SVB-AF-0618	600 H x 1800 W
	SVB-AF-0912	900 H x 1200 W
	SVB-AF-0915	900 H x 1500 W
	SVB-AF-0918	900 H x 1800 W
	SVB-AF-1212	1200 H x 1200 W
	SVB-AF-1215	1200 H x 1500 W
	SVB-AF-1218	1200 H x 1800 W

Bridged panels with flat aluminium edges all round

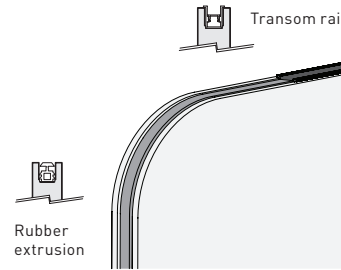

code	SVB-RT-0612	600 H x 1200 W
	SVB-RT-0615	600 H x 1500 W
	SVB-RT-0618	600 H x 1800 W
	SVB-RT-0912	900 H x 1200 W
	SVB-RT-0915	900 H x 1500 W
	SVB-RT-0918	900 H x 1800 W
	SVB-RT-1212	1200 H x 1200 W
	SVB-RT-1215	1200 H x 1500 W
	SVB-RT-1218	1200 H x 1800 W

Bridged panels with rubber edges and aluminium transom top rail

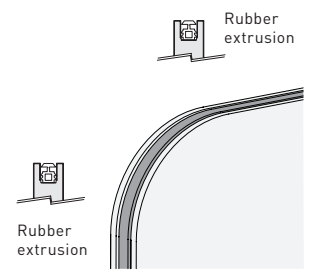

code	SVB-RF-0612	600 H x 1200 W
	SVB-RF-0615	600 H x 1500 W
	SVB-RF-0618	600 H x 1800 W
	SVB-RF-0912	900 H x 1200 W
	SVB-RF-0915	900 H x 1500 W
	SVB-RF-0918	900 H x 1800 W
	SVB-RF-1212	1200 H x 1200 W
	SVB-RF-1215	1200 H x 1500 W
	SVB-RF-1218	1200 H x 1800 W

Bridged panels with rubber edges all around

VIDE PANEL ACCESSORIES

Powder coated steel accessories that hang from Vide panels with a top transom rail only.

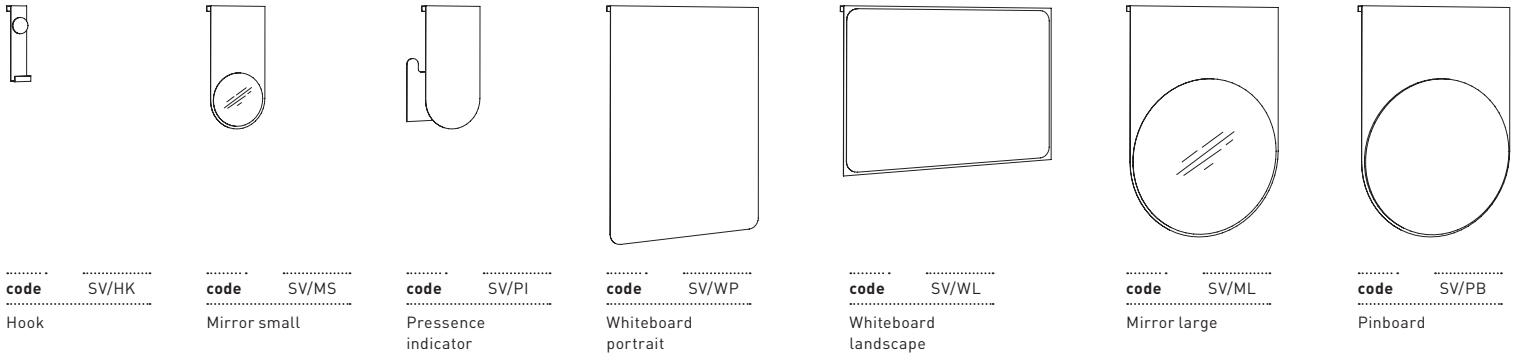

code SV/HK
 Hook

code SV/MS
 Mirror small

code SV/PI
 Presence indicator

code SV/WP
 Whiteboard portrait

code SV/WL
 Whiteboard landscape

code SV/ML
 Mirror large

code SV/PB
 Pinboard

Product Specifications

warranty

Warranty

The manufacturer warrants the system for a period of no less than 5 years against faulty materials and workmanship and guarantees the supply of parts and service of all standard components for a period of no less than 10 years from the date of installation.

Sustainable

Vide Panel is manufactured in accordance with international environmental standards: ISO 14001. All aluminium is powder coated to Australian Standard AS-NZ3570.



Melbourne Head Office

Schiavello (Vic) Pty Ltd
1 Sharps Road
Tullamarine VIC Australia 3043
T: 61) 3 9330 8888
F: 61) 3 9330 8899

Melbourne Showroom

Schiavello (Vic) Pty Ltd
Metropol
8 Whiteman Street
Southbank VIC Australia 3006
T: 61) 3 9674 1500
F: 61) 3 9674 1650

Adelaide

Schiavello (SA) Pty Ltd
Ground Floor, 101 Currie Street
Adelaide SA Australia 5000
T: 08) 8112 2300
F: 08) 8231 1419

Brisbane

Schiavello (Qld) Pty Ltd
265 Coronation Drive
Milton QLD Australia 4064
T: 07) 3368 3388
F: 07) 387602130

Canberra

Schiavello (ACT) Pty Ltd
2-6 Collie Street
Fyshwick ACT Australia 2609
T: 02) 6124 0500
F: 02) 6280 4370

Perth

Schiavello (WA) Pty Ltd
1315 Hay Street
West Perth WA Australia 6005
T: 08) 9420 6588
F: 08) 9322 1337

Sydney

Schiavello (NSW) Pty Ltd
69 Campbell Street
Surry Hills NSW Australia 2010
T: 02) 9211 3311
F: 02) 9212 3788

Singapore

Schiavello Singapore Pte Ltd
No.1 Magazine Road
#01-05 Central Mall
Singapore 059567
T: 65) 6533 8011
F: 65) 6533 2811

schiavello.com/vid
SCH/VID01-C

Schiavello Group Pty Ltd
reserves the right to change
any or all details without
prior notice. All dimensions
stated within this document
are nominal and/or approximate
only and subject to variation.

schiavello