

# BOMBA



**schiaavello**

# IVAN WOODS

The late Ivan Woods designed interiors and products for over 30 years. His work drew inspiration from his travels and interior architecture training in Perth, Australia. Working across projects within the UK, US, Germany and Italy, Ivan specialised in hotel and workspace design.

Ivan developed the idea for Bomba in response to the need to provide an informal, soft seating option that was inherently modular in nature, but with a contemporary lounge aesthetic. Creating a refined and strong product with Bomba's unusual amount of joints was intricate and difficult work.



Bomba features soft, angled volumes floating on polished aluminium or Oak legs. The legs are available in polished, black-coated, grey-coated and white-coated aluminium. The Oak legs and arms are available in a selection of stains or paints, each variation providing a unique aesthetic.





Much like its namesake, the Bomba – a Latin American musical style where the dancer's movements dictate the beat of the drums – Bomba Sofa is led by the user's requirements.

Bomba Tables harmoniously integrate with the Bomba Sofa system. An elegant family of occasional tables, these serve to independently complement a range of seating scenarios. Designed by Ivan Woods, the round, square or rectangular low floating tops sit upon distinctive

tapered legs in timber or aluminum to create soft, contemporary profiles. Suiting various personalities, tops are available in paint, veneer and stains in solid Oak, while aluminum legs can be polished or powder coated.



# Configurations

Bomba Sofa is a part of a system that includes individual pieces of furniture that create stand alone, linear and corner configurations. Depending on the configuration selection, the Bomba Sofa system can take an either formal or casual attitude across small, medium and large environments.

## Stand alone

CODE: BBS1-B1

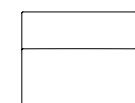
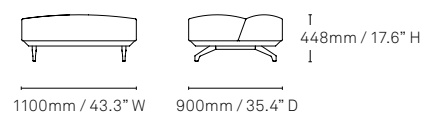

## One-seater sofa

CODE: BBS1-TA1

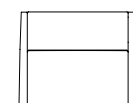
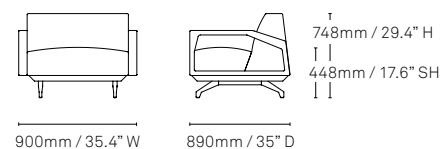

## Two-seater sofa

CODE: BBS1-TA2

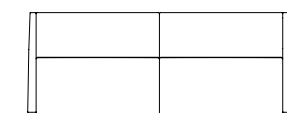
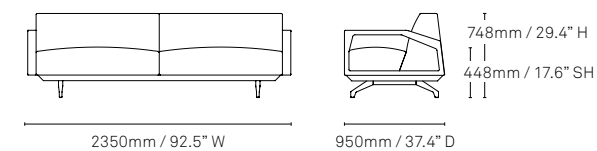

## Three-seater sofa

CODE: BBS1-TA3

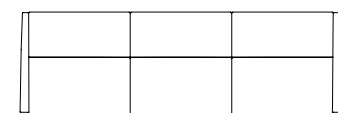
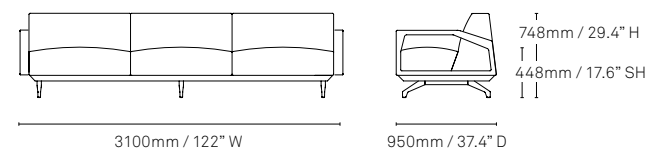

## Corner module sofa one

CODE: BBC-CNR-201

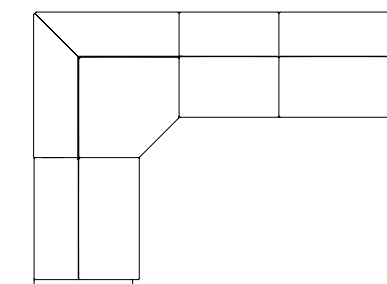
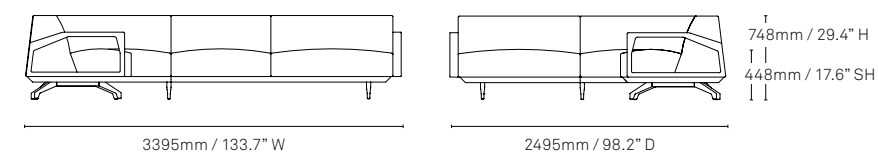

## Corner module sofa two

CODE: BBC-CNR-202

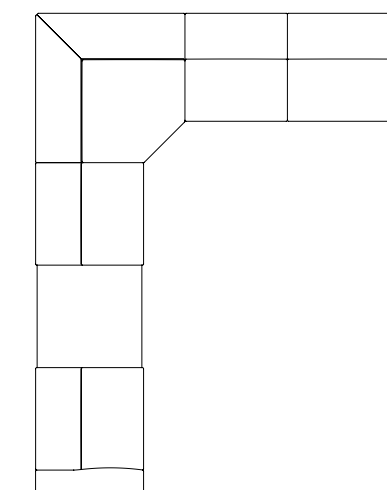
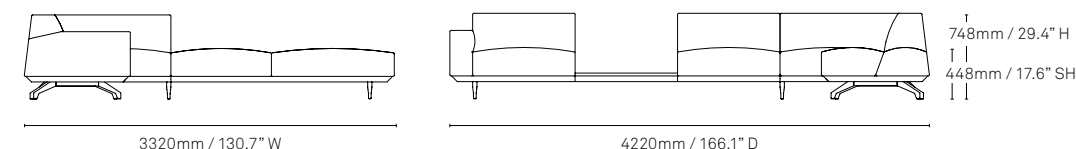

## Corner module sofa three

CODE: BBC-CNR-203

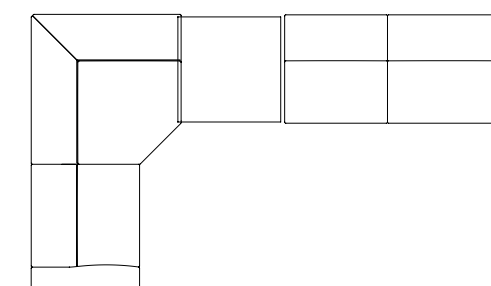
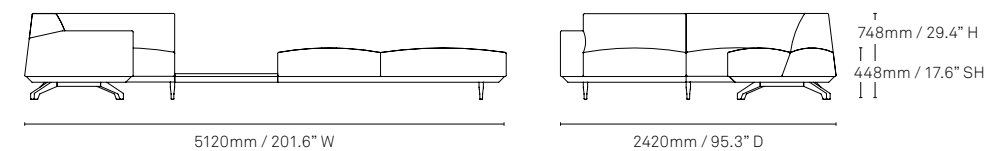

Corner module sofa four

CODE: BBC-CNR-204

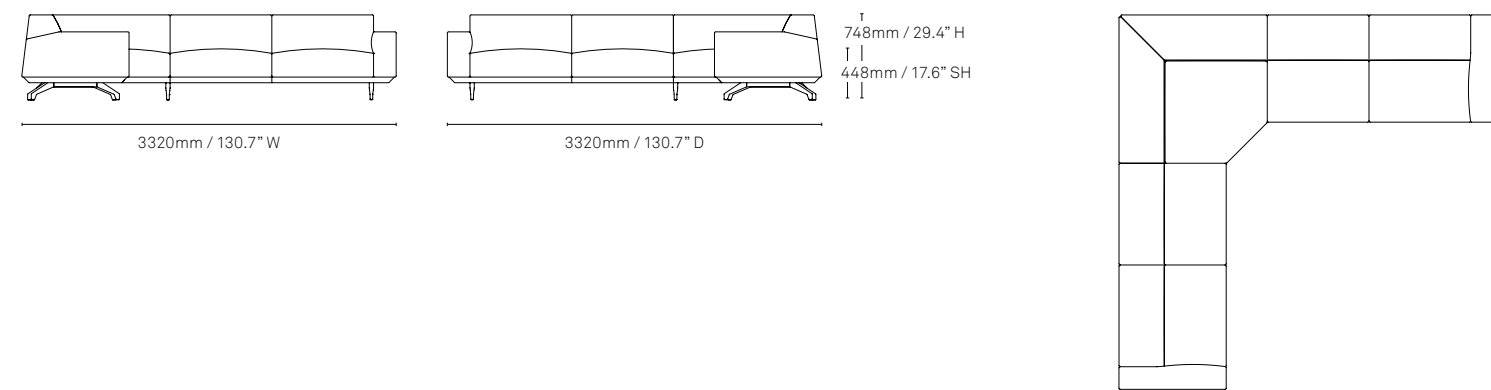

Corner module sofa five

CODE: BBC-CNR-205

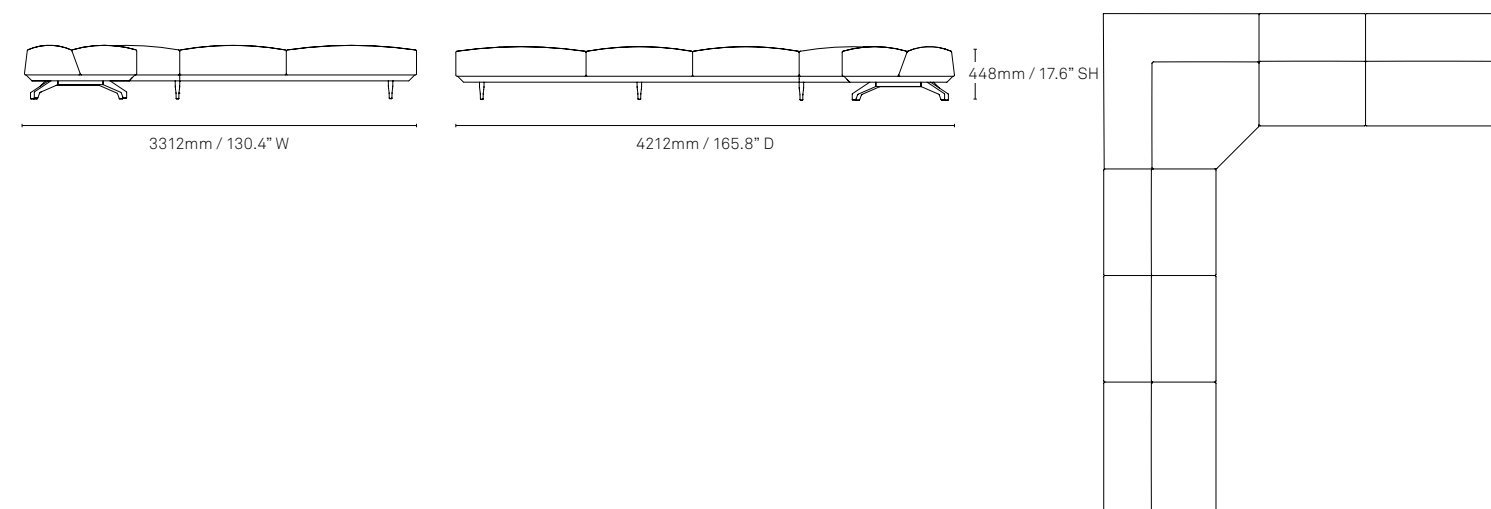

Linear module sofa one

CODE: BBC-LIN-301

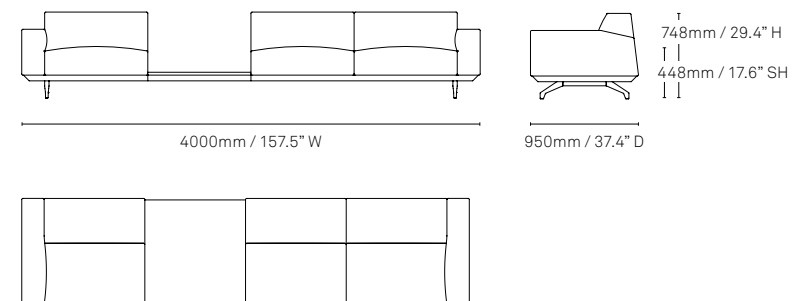

Linear module sofa two

CODE: BBC-LIN-302

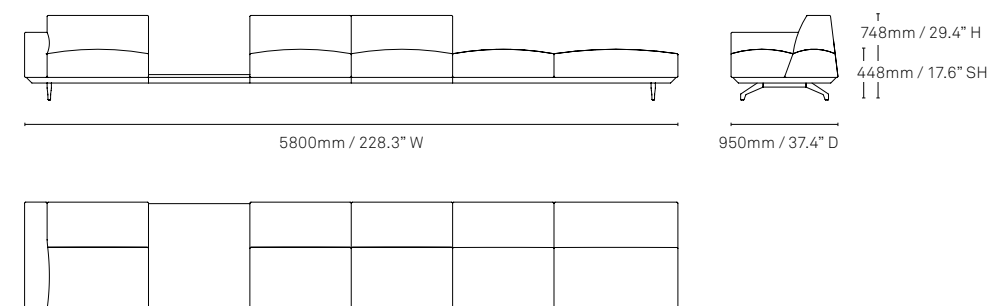

Linear module sofa three

CODE: BBC-LIN-303

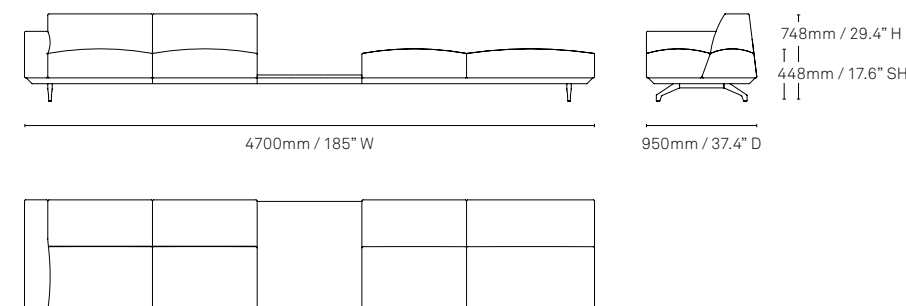

Linear module sofa four

CODE: BBC-LIN-304

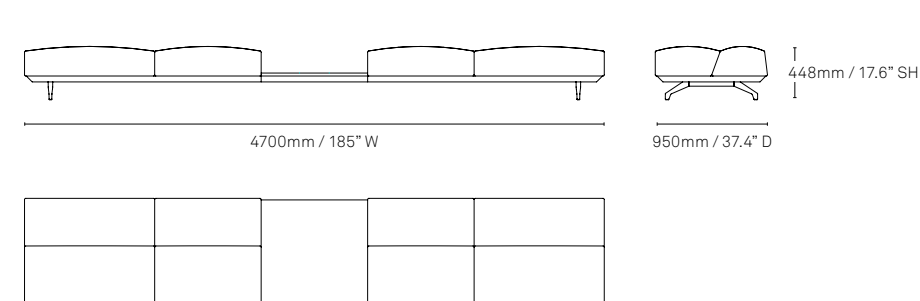

Linear module sofa five

CODE: BBC-LIN-305

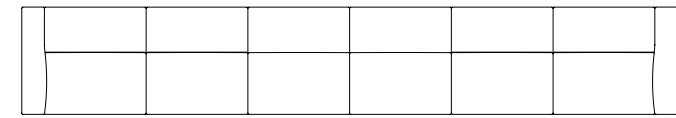
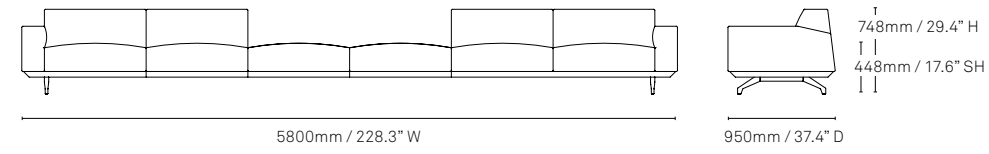

Linear module sofa six

CODE: BBC-LIN-306

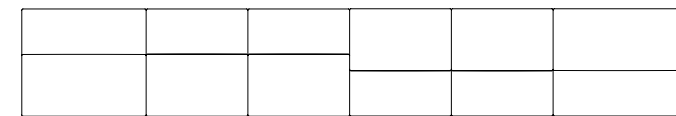
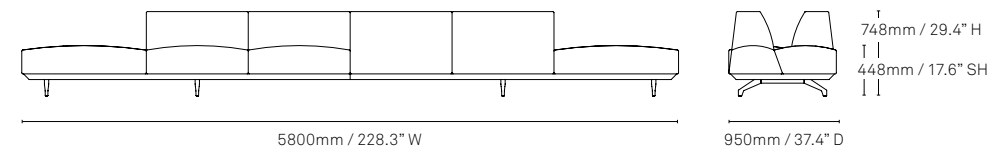

Linear module sofa seven

CODE: BBC-LIN-307

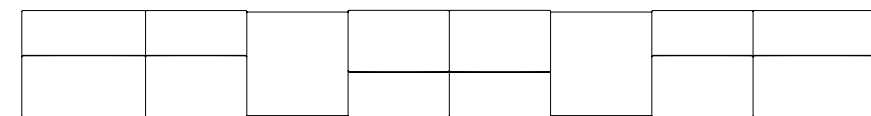
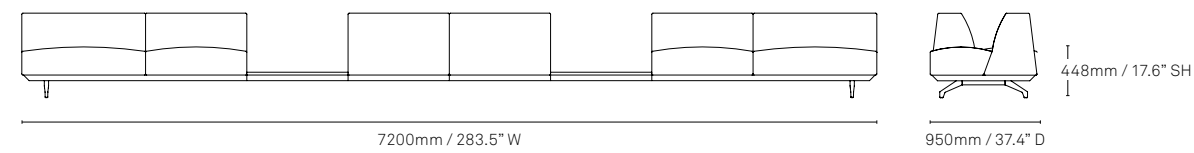

Linear module sofa eight

CODE: BBC-LIN-308

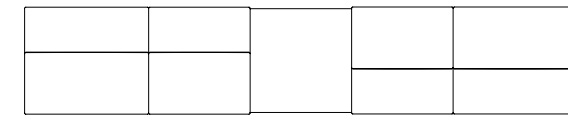
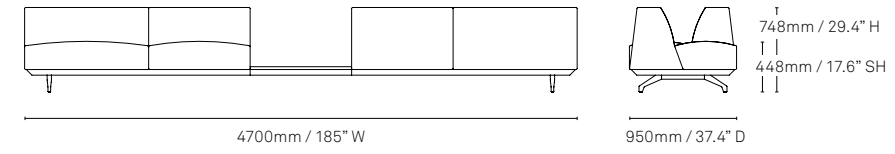

Linear module sofa nine

CODE: BBS6-TA3T9

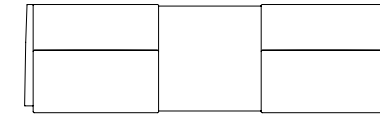
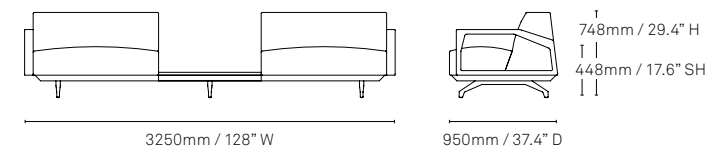

Linear module sofa ten

CODE: BBS6-TA3T9L-REV

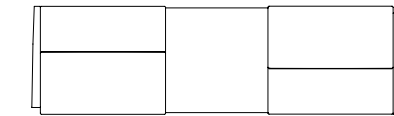
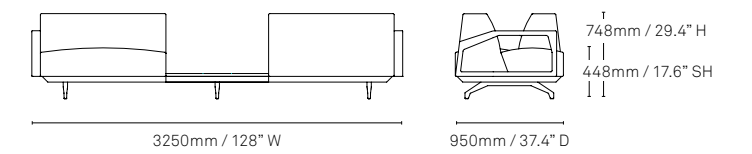

Linear module sofa eleven

CODE: BBS6-B3T9

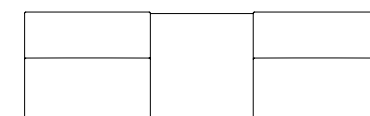
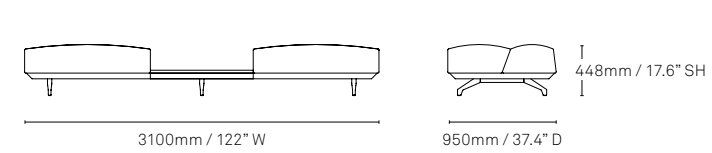

# Table Specifications

## Square Table

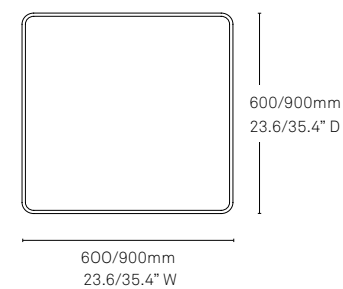

Available in  
600 x 600mm / 23.6" x 23.6"  
900 x 900mm / 35.4" x 35.4"

## Rectangle Table

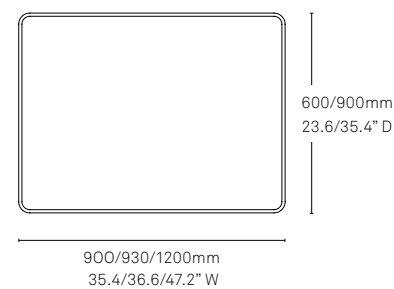

Available in  
900 x 600mm / 35.4" x 23.6"  
930 x 600mm / 36.6" x 23.6"  
1200 x 600mm / 47.2" x 23.6"  
1200 x 900mm / 47.2" x 35.4"

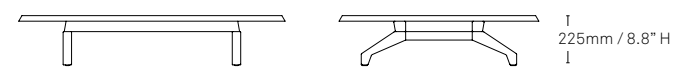
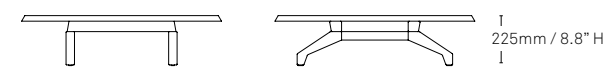

## Round Table

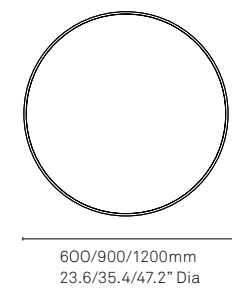

Available in  
600mm / 23.6" Dia  
900mm / 35.4" Dia  
1200mm / 47.2" Dia

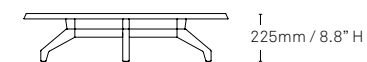

All measurements are in millimeters (mm)





# ColourLab

Schiavello's innovative ColourLab brings a considered and cohesive palette of finishes to working and living spaces. Curated by Giulio Ridolfo and developed by Schiavello, the palette beautifully balances colour, texture and layering across a variety of materials.

## FABRIC

### CATEGORY 1 Edge, Focus & Messenger

#### EDGE / Category 1

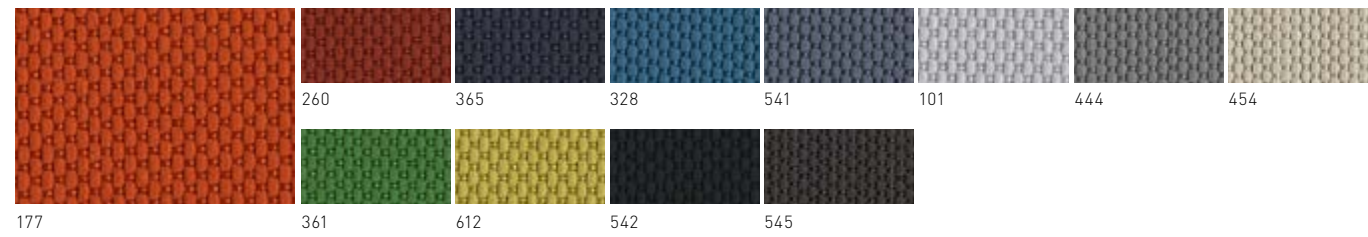

#### FOCUS / Category 1

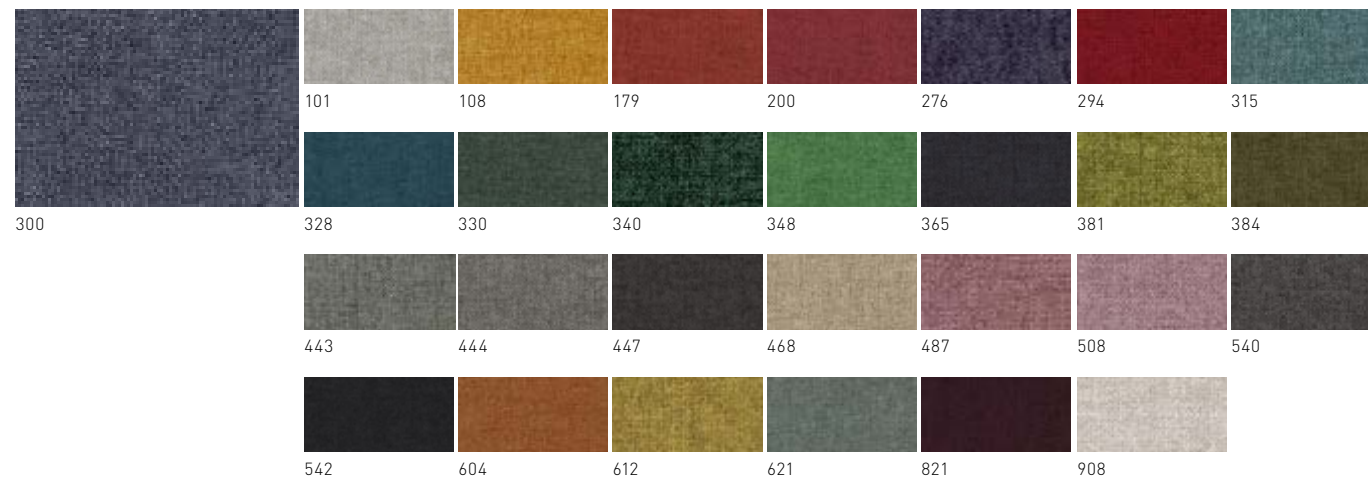

#### MESSENGER / Category 1

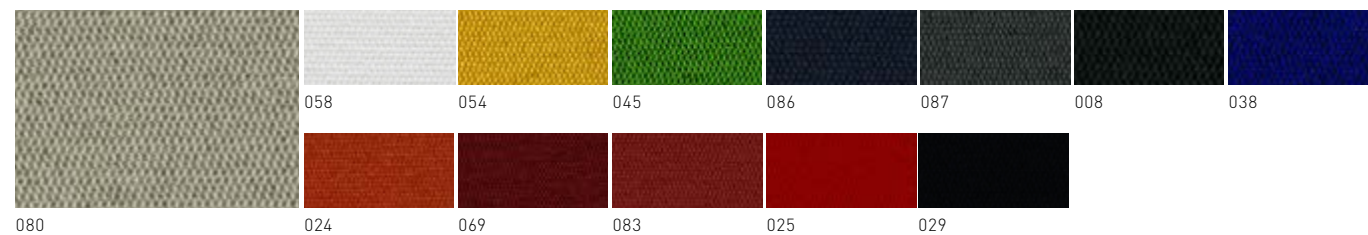

**CATEGORY 2**  
Metric

**CATEGORY 3**  
Atlas & Revive 1

**METRIC / Category 2**

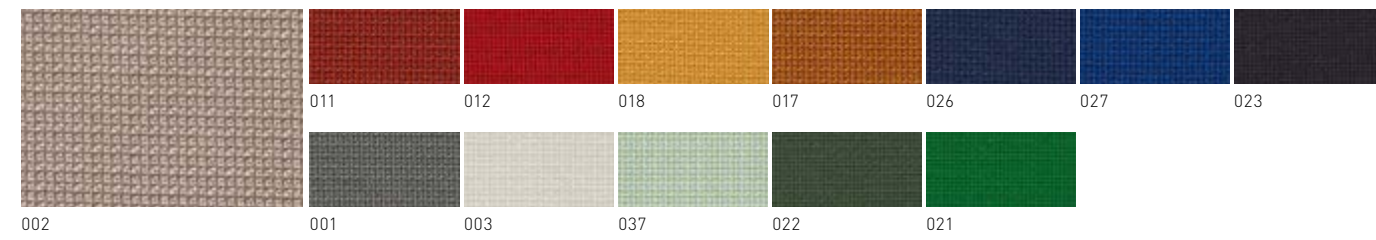

**ATLAS / Category 3**

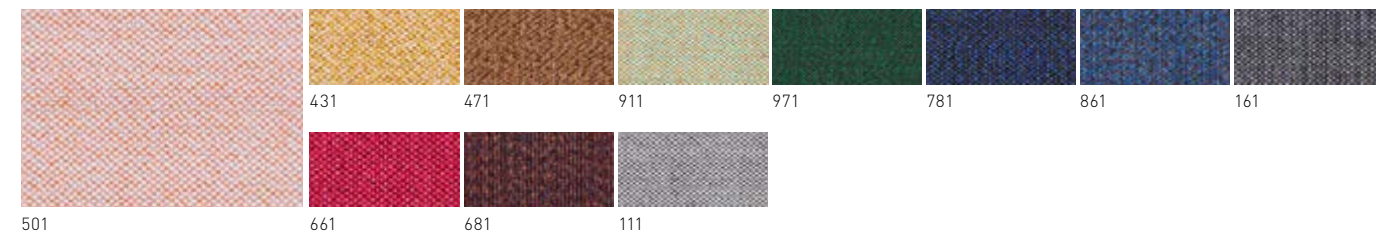

**REVIVE 1 / Category 3**



**CATEGORY 4**  
Glow, Recheck,  
Remix 3 & Rime

**GLOW / Category 4**

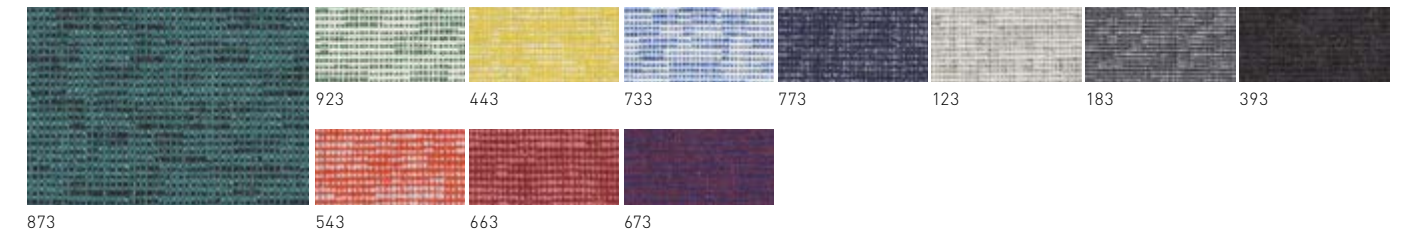

**RECHECK / Category 4**



**REMIX 3 / Category 4**



**RIME / Category 4**



**CATEGORY 5**  
Steelcut Trio 3  
& Tonica 2

**STEELCUT TRIO 3 / Category 5**



**TONICA 2 / Category 5**

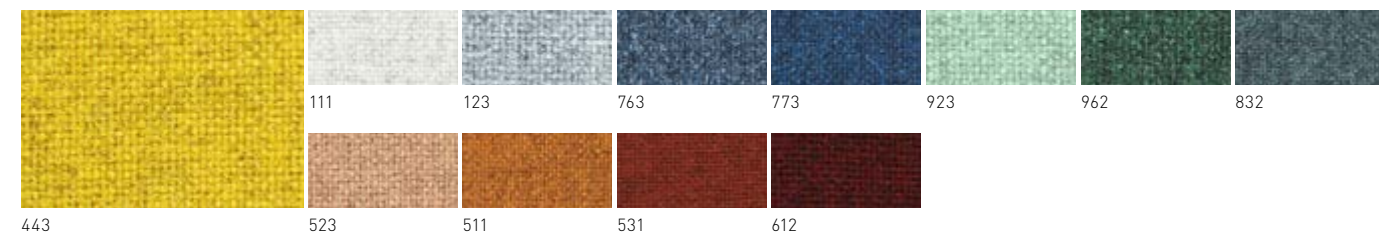

HEALTHCARE  
FABRIC

**CATEGORY 1.5**  
Silk  
**CATEGORY 2**  
Rave  
**CATEGORY 2**  
Trieste

**SILK / Category 1.5**

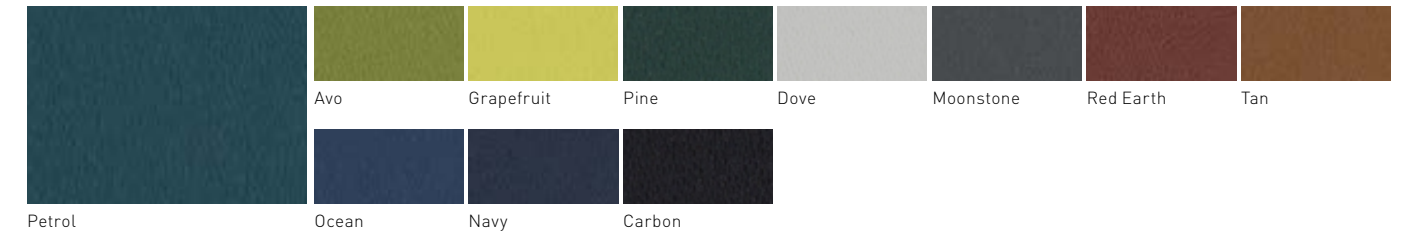

**RAVE / Category 2**



**TRIESTE / Category 2.5**

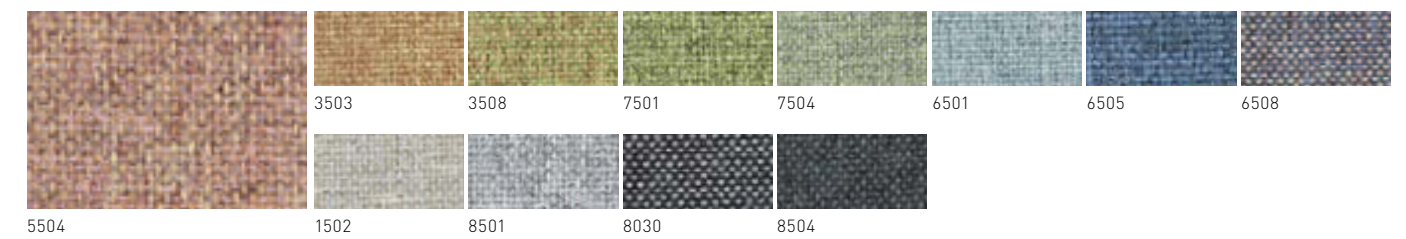

LEATHER

**MATADOR / Category 2**

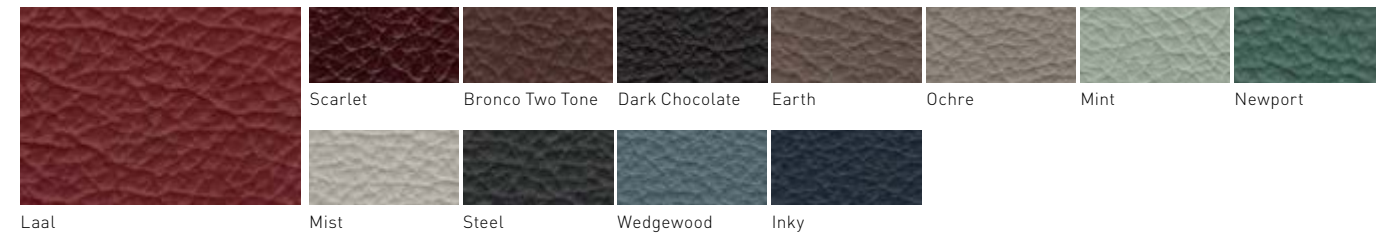

**MEDICI / Category 3**



**HEIRLOOM / Category 4**

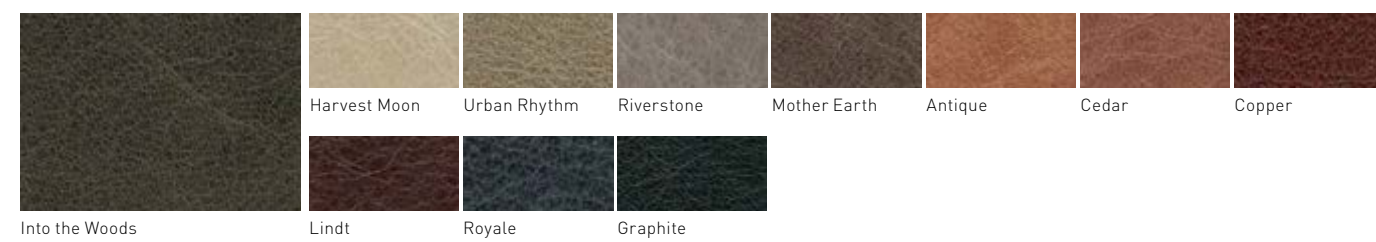

**CATEGORY 2**

Matador

**CATEGORY 3**

Medici

**CATEGORY 4**

Heirloom



ALUMINUM



Aluminium

METAL POWDER COAT & POLISH

FINISH

- Satin
- ‡ Texture



Ash • Strata ‡• Parchment ‡• Obsidian Glass ‡• Black ‡• Stone Grey •



Silk Grey • Cement Grey • Grey Beige • Oxide Red • Signal Brown • Orange Brown •



Pale Green • Emerald Green • Fir Green • Ruby Red • Traffic Red • Blush •



Colza Yellow • Sulfur Yellow • Steel Blue • Gentian Blue •

TIMBER NATURAL

Species



Oak

Applied Finishes



Limewood Walnut Bianco Walnut Milano

TIMBER PAINT



Ash Strata Parchment Obsidian Glass Black Stone Grey



Silk Grey Cement Grey Grey Beige Oxide Red Signal Brown Orange Brown



Pale Green Emerald Green Fir Green Ruby Red Traffic Red Blush



Colza Yellow Sulfur Yellow Steel Blue Gentian Blue

TIMBER WASH



Ash Strata Parchment Obsidian Glass Black Stone Grey



Silk Grey Cement Grey Grey Beige Oxide Red Signal Brown Orange Brown



Pale Green Emerald Green Fir Green Ruby Red Traffic Red Blush



Colza Yellow Sulfur Yellow Steel Blue Gentian Blue





## Ecology and sustainability

Schiavello's most important commitment to sustainability is the company-wide Environmental Management System under ISO 14001. The environmental design principles realised means we design for the environment, focusing on efficient energy use and minimum emissions, longevity and durability, re-use and recycling of our products.

Our principles of ME WE (Materials, Energy, Waste Emissions) give us a simple way to think about how our operations impact the environment.

Printed on an Australian made paper stock that is PEFC Certified and made from elemental chlorine-free bleached pulp sourced from sustainably managed forests and non-controversial sources. It is manufactured by an ISO 14001 certified mill using renewable energy sources.



FS 604920

EMS 604919

## About Schiavello

Schiavello is a multi-disciplinary company dedicated to developing intelligent, inspiring, ecological and resilient solutions for the office, the home and public spaces.

Schiavello's concepts and products are developed in Australia by applying a design process that brings together the company's core design principles and engineering with the creativity of local and international designers.

The Schiavello head office and world-class manufacturing facilities are integral to our continually developing rich tapestry of knowledge. This knowledge ultimately assists us in informing the right solutions and tools for each organisation's needs and people, allowing us to consistently achieve our philosophy that 'Anything is possible'.

To find a Schiavello showroom or partner in your area, please visit [schiavellofurniture.com/find-us](https://www.schiavellofurniture.com/find-us)

All intellectual property rights and copyrights are reserved. Nothing contained in this brochure may be reproduced without written permission. Schiavello Group Pty Ltd reserves the right to change any or all details without prior notice. All dimensions stated within this document are nominal and/or approximate only and subject to variation.

SCH/C49D1-I